

## Technical Bulletin 5.0

### Marking films - Application guide

The present Technical Bulletin 5.0 provides detailed information on how to use Signage films from MACtac. The application techniques that are described help users by making their job easier, or by saving them time.

However, we know that all the advice in the world cannot replace the skill and experience of professional users, without whom no high-quality work would be possible.

## TABLE OF CONTENT

<b>1. Basic tools for vinyl application</b>	<b>2</b>
<b>2. Storage</b>	<b>2</b>
<b>3. Cutting Process</b>	<b>2</b>
<b>4. Weeding Process</b>	<b>3</b>
<b>5. Application tape</b>	<b>4</b>
<b>6. Cleaning procedure</b>	<b>5</b>
<b>7. Marking Films Application Method</b>	<b>5</b>
7.2 Wet method	5
7.2 Dry method	7
7.2.a Small surface areas (<0.5 m <sup>2</sup> )	7
7.2.b Large flat surfaces (>2 m <sup>2</sup> ) : hinge method	8
7.2.c 2D areas (vinyl can be applied following these surfaces)	9
7.2.d Complex curves – 3D areas (vinyl can't follow surfaces irregularities)	9
7.2.e Rivets	10
7.3 Transparent, translucent or etched films	11
7.4 Edge Sealing	12
<b>8. Vinyl Removal</b>	<b>12</b>

## 1. Basic tools for vinyl application

To be able to apply the Signage adhesive films, use the following tools:

- > pair of scissors
- > cutter
- > ruler
- > pair of cotton gloves or a piece of cotton fabric
- > felt squeegee
- > plastic squeegee
- > masking tape
- > variable-power hot air gun
- > clean room - heated if necessary
- > Cleaning solutions i.e isopropanol or Mactac cleaner

## 2. Storage

MACtac provides a two-year storage guarantee for its marking films on condition that they have been kept at temperatures of 15 to 25°C and at humidity of 40 to 60%.



Temperature  
15 – 25°C



Humidity  
40 – 60%

Also avoid directly exposing the vinyl to high temperatures (near radiators, in direct sunlight, etc.)

OK

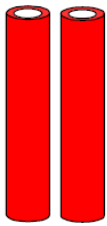

NOT OK



Any part-used rolls should be kept upright or hung on racks.

At no time should they be placed on their sides as this could lead to large areas of matification appearing throughout the roll.

## 3. Cutting Process



OK



NOT OK

Use a knife with a sharp blade. Blunt or worn knives will result in untidy cuts (known as “jagged edging”).

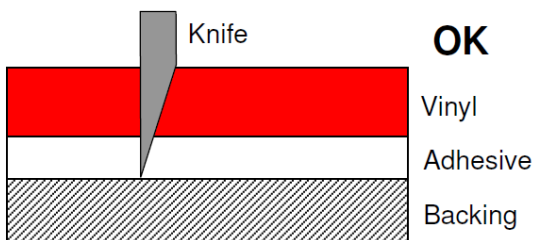

Cut to the correct depth. The knife should cut all the way through the vinyl and the adhesive.

Contact

Email: [contact.mactac@mactac.eu](mailto:contact.mactac@mactac.eu)  
Website: [www.mactacgraphics.eu](http://www.mactacgraphics.eu)

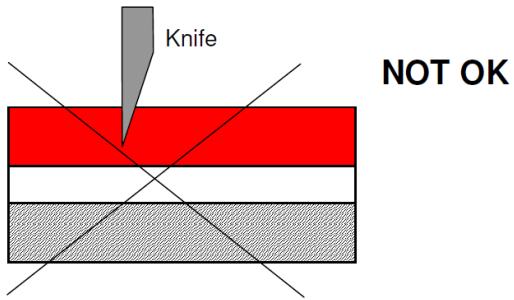

If the cut is not deep enough (the vinyl and/or if the adhesive is not cut all the way through), the letters and logos that you have cut out could be pulled away during stripping.

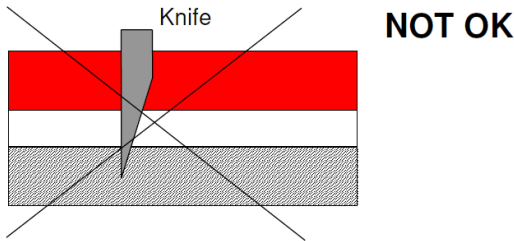

If cuts are too deep, then the backing could split when the letters or logos are being transferred onto the MACtransfer tape.

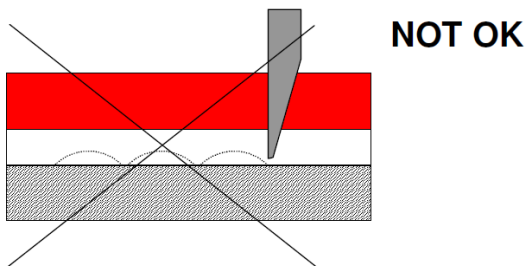

Applying too much pressure when using a blunt knife could result in the knife bouncing off the backing paper, which means that the adhesive will not be cut all the way through.

#### 4. Weeding Process



Maximum  
1 hour

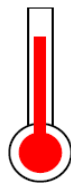

Temperature :  
15-23°C  
Max 25°C

MACtac recommends vinyl weeding takes place soon after cutting.

If weeding is delayed too long and if the ambient temperature is too high, the adhesive layer could "reseat" itself and could therefore hamper the ease of weeding.

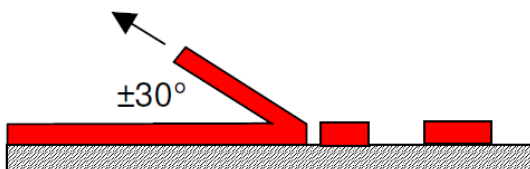

For best weeding results, use a cleaving angle of  $\pm 30^\circ$  and pull at a steady speed.

## 5. Application tape

The application tape should preferably be laminated using a laminator.  
If this is not possible, then use the following procedure:

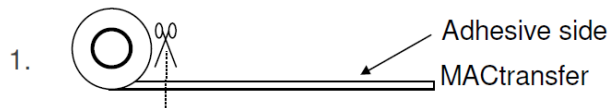

Roll the MACtransfer (=AT) on a table with the adhesive facing upwards.  
The AT dimension has to be bigger than the lettering / logo to be transferred.

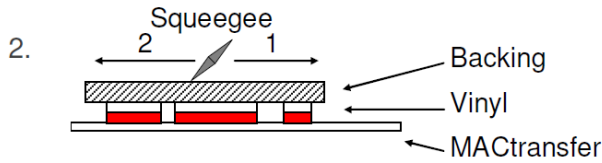

Place the lettering / logo on the AT.  
Squeegee the reverse side of the marking film backing with a stiff plastic squeegee, working outwards from the centre.

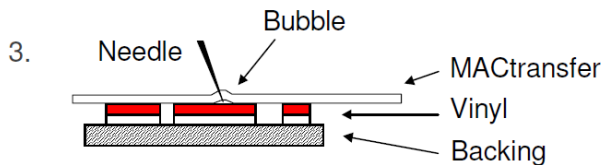

Turn the layers over and prick any air bubbles trapped between the application tape and the vinyl using a needle or a cutter (bubbles could cause wrinkling when applying the marking film on the substrate).

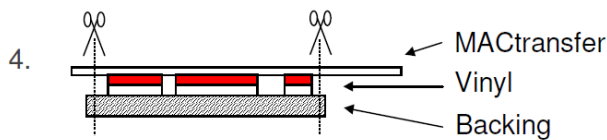

Cut the AT to the same size as the marking film.  
To carry the vinyl with the AT on it to the place where it is to be applied, roll it up with a diameter of at least 5 cm, with the AT facing outwards, or carry it flat.

In the following table, you can find the type of Application tapes to be used for the Signage series:

Brand	Series	Application Paper				
		MACtransfer 220 Low tack	MACtransfer 215 Medium tack	MACtransfer 100 High Grade High tack	MACtransfer 400 Low tack	MACtransfer 500 Medium tack
MActac Signage Portfolio	MACal 8000 Series	<input checked="" type="checkbox"/>	<input checked="" type="checkbox"/>	<input checked="" type="checkbox"/>	<input checked="" type="checkbox"/>	<input checked="" type="checkbox"/>
	MACal 8200 Pro Series	<input checked="" type="checkbox"/>	<input checked="" type="checkbox"/>	<input checked="" type="checkbox"/>	<input type="checkbox"/>	<input checked="" type="checkbox"/>
	MACal 8300 Pro Series	<input type="checkbox"/>	<input checked="" type="checkbox"/>	<input checked="" type="checkbox"/>	<input type="checkbox"/>	<input checked="" type="checkbox"/>
	MACal 8900 Pro Series	<input checked="" type="checkbox"/>	<input checked="" type="checkbox"/>	<input checked="" type="checkbox"/>	<input type="checkbox"/>	<input checked="" type="checkbox"/>
	MACal 9300 Series	<input checked="" type="checkbox"/>	<input checked="" type="checkbox"/>	<input checked="" type="checkbox"/>	<input checked="" type="checkbox"/>	<input checked="" type="checkbox"/>
	MACal 9700 Pro Series	<input checked="" type="checkbox"/>	<input checked="" type="checkbox"/>	<input checked="" type="checkbox"/>	<input checked="" type="checkbox"/>	<input checked="" type="checkbox"/>
	MACal 9800 Pro Series	<input type="checkbox"/>	<input checked="" type="checkbox"/>	<input checked="" type="checkbox"/>	<input checked="" type="checkbox"/>	<input checked="" type="checkbox"/>
	MACal 9800 Pro BF Series	<input checked="" type="checkbox"/>	<input checked="" type="checkbox"/>	<input checked="" type="checkbox"/>	<input checked="" type="checkbox"/>	<input checked="" type="checkbox"/>
	MACal 9800 HT Pro Series	<input type="checkbox"/>	<input checked="" type="checkbox"/>	<input checked="" type="checkbox"/>	<input type="checkbox"/>	<input checked="" type="checkbox"/>
	MACal 9800 Cast	<input type="checkbox"/>	<input type="checkbox"/>	<input checked="" type="checkbox"/>	<input type="checkbox"/>	<input type="checkbox"/>
	MACal GlassDecor 500 Series	<input type="checkbox"/>	<input checked="" type="checkbox"/>	<input checked="" type="checkbox"/>	<input checked="" type="checkbox"/>	<input checked="" type="checkbox"/>
	MACal GlassDecor 700 Series	<input checked="" type="checkbox"/>	<input checked="" type="checkbox"/>	<input checked="" type="checkbox"/>	<input checked="" type="checkbox"/>	<input checked="" type="checkbox"/>
	MACal Truck Tarp series	<input type="checkbox"/>	<input checked="" type="checkbox"/>	<input checked="" type="checkbox"/>	<input type="checkbox"/>	<input type="checkbox"/>
	Window Etch Film	<input type="checkbox"/>	<input checked="" type="checkbox"/>	<input checked="" type="checkbox"/>	<input type="checkbox"/>	<input checked="" type="checkbox"/>
	MACmask 84817	<input type="checkbox"/>	<input type="checkbox"/>	<input checked="" type="checkbox"/>	<input type="checkbox"/>	<input checked="" type="checkbox"/>
	MACmask 28180	<input checked="" type="checkbox"/>	<input checked="" type="checkbox"/>	<input checked="" type="checkbox"/>	<input type="checkbox"/>	<input checked="" type="checkbox"/>
	MACcrystal 8400 Series	<input checked="" type="checkbox"/>	<input checked="" type="checkbox"/>	<input checked="" type="checkbox"/>	<input checked="" type="checkbox"/>	<input checked="" type="checkbox"/>
	MacLite 5700 Series	<input type="checkbox"/>	<input checked="" type="checkbox"/>	<input checked="" type="checkbox"/>	<input checked="" type="checkbox"/>	<input checked="" type="checkbox"/>
	MACal 1000 Series	<input type="checkbox"/>	<input checked="" type="checkbox"/>	<input checked="" type="checkbox"/>	<input type="checkbox"/>	<input type="checkbox"/>
MACal 1100 Series	<input type="checkbox"/>	<input type="checkbox"/>	<input checked="" type="checkbox"/>	<input type="checkbox"/>	<input type="checkbox"/>	

## 6. Cleaning procedure

Even if they appear clean, all surfaces should be cleaned using the procedure below:  
Clean with soapy water, then rinse with clean water (do not leave any traces of soap on the surface).  
Clean away any grease using isopropyl alcohol, denatured petrol or MACTac Cleaner.  
Dry the surface using a dry cloth or a clean paper towel which will not leave any small pieces behind, before the isopropyl alcohol or denatured petrol has had a chance to evaporate.  
See TB 1.0 'Mactac Liquids User Instruction' for more detailed information.

## 7. Marking Films Application Method

A wet method or dry method application technique may be used. The method chosen should suit the size of the decorative feature to be applied and the complexity of the surface to be decorated. Dry application is the most reliable method. Bubble free products should be applied only in the Dry method.

### 7.2 Wet method

This method of application produces very little initial adhesion. This allows the applicator to position the vinyl where required, avoiding air bubbles and folds.

The adhesion will gradually increase after several hours as the water evaporates.

The final adhesion will be reached after 24 or 48 hours.

It is not advisable to apply a marking film using the wet method in temperatures lower than 15°C.

#### Advantages of the wet method:

Allows the vinyl to be applied to surfaces in high ambient temperatures (>25-30°C).

It makes it easier to apply large sections of vinyl on flat or slightly curved surfaces.

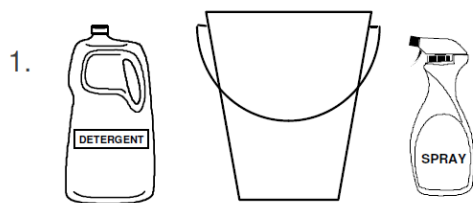

Use the MACTac Application fluid or prepare a solution of soapy water (one capful of detergent to 10 litres of water) and pour it into a spray bottle.

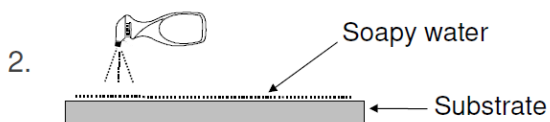

Use the spray bottle to wet the entire substrate surface (do not use a sponge or a cloth as these can leave dust, fluff, etc.).

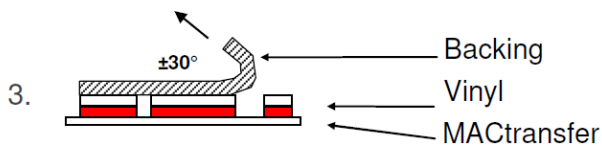

Make sure the adhesive film is flat on a table. Pull the backing off it (and not the reverse) at an angle of 30°.

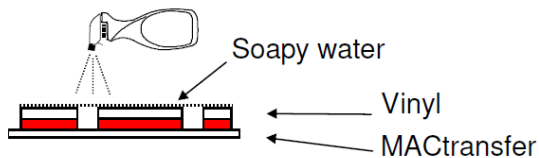

Wet the adhesive all over using a spray Bottle.

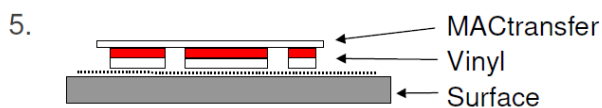

Place the marking film on the wet substrate surface.

If the vinyl does not have any application tape on it, wet the entire surface of the film. This will make it easier to slide the plastic squeegee without scratching the vinyl

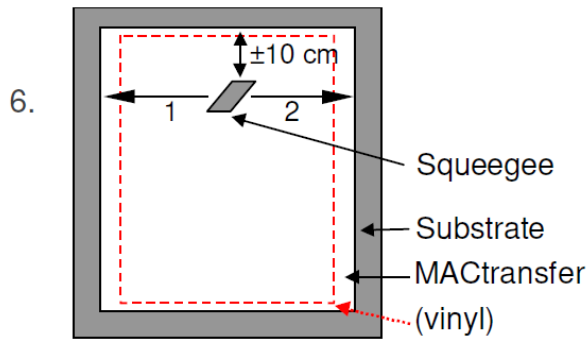

Squeegee horizontally, working from the centre outwards to the left and then the right stopping  $\pm 10$  cm from the top edge of the vinyl.  
Apply enough pressure to squeeze out any water trapped between the adhesive and the substrate surface.

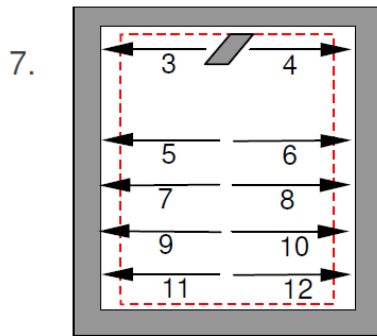

Squeegee the last 10 cm of the top edge working from the centre outwards, to the left and then the right.  
Continue to squeegee horizontally moving from the centre outwards with overlapping movements.  
Check that no pockets of water have been trapped. If this is the case, squeegee from the centre to the edge in order to squeeze it out.  
Wipe the vinyl and the edges.

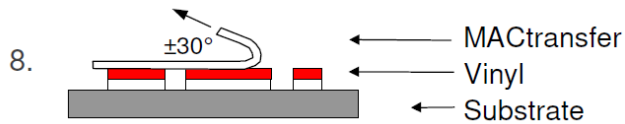

If the marking film is covered with AT, pull it off at a steady speed, at a cleaving angle of 0 to 30°.  
It is advisable to wait between 30 and 90 minutes (depending on the ambient temperature) before removing the AT.  
It should not be left in contact with the vinyl for more than 24 hours.

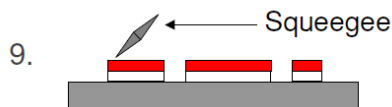

After these 30-90 minutes squeegee the film again, paying particular attention to the edges.

## 7.2 Dry method

Dry application is a safer application method because the marking film reaches its final adhesion quicker than using the wet application method.

The lowest application temperature for marking films on flat or slightly curved surfaces is 10°C. On three-dimensional surfaces that require the vinyl to be shaped (over rivet heads, corrugations, welded areas, etc.) only MACfleet 6500 or IMAGin JT 5529 P may be used. Their minimum application temperature is also 10°C but require the use of a heat gun.

### 7.2.a Small surface areas (<0.5 m<sup>2</sup>)

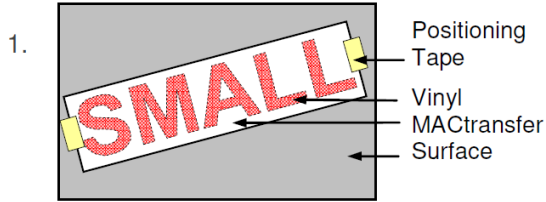

Place the application tape on top of the lettering or logo. Position the lettering or the logo WITHOUT REMOVING THE BACKING, using positioning tape at each end.

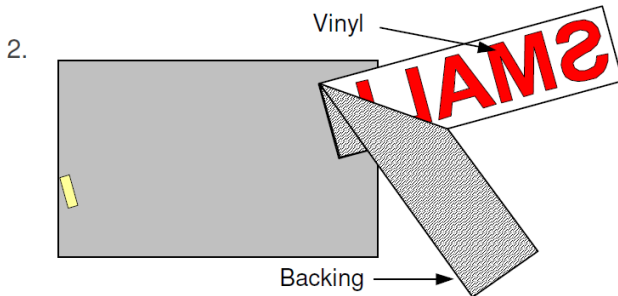

Cut one edge of the positioning tape. Peel the backing off.



Position the lettering or the logo once again on the spot marked by the piece of positioning tape. Squeegee quickly and firmly from the centre outwards in overlapping movements.

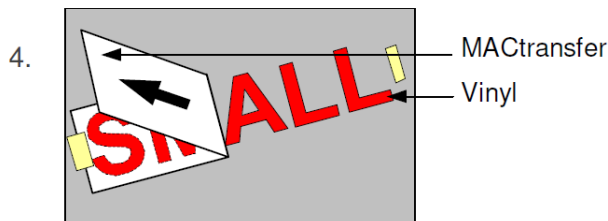

Pull the AT off at steady speed, at a cleaving angle of 0 to 30°. Prick any air bubbles (\*) trapped between the vinyl and the substrate.

(\*) In the event that "tiny bubbles" of air get trapped between the marking film and the substrate surface (bubbles which have a diameter < 2 mm), there is no need to do anything as they will disappear after a few days due to the porosity of the vinyl.

If the bubbles are over 2 mm in diameter, use the following procedure:

1 - try to collect the bubbles together without putting the vinyl out of shape.

2 - prick the bubble at one end.

3- pushing from the side opposite the opening, squeeze the air out through the opening

7.2.b Large flat surfaces (>2 m<sup>2</sup>) : hinge method

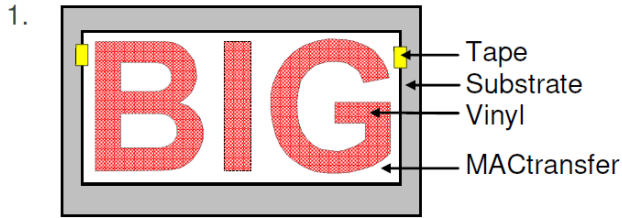

For surfaces of this kind, it is absolutely necessary to apply AT to the lettering or logo. Position the lettering or the logo WITHOUT REMOVING THE BACKING by using a piece of positioning tape at each end.

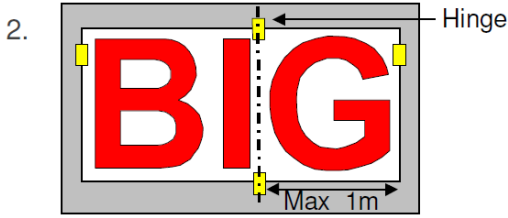

Make a hinge perpendicular to the largest dimension of the letters or logo, no more than 1m away from any one of the edges.

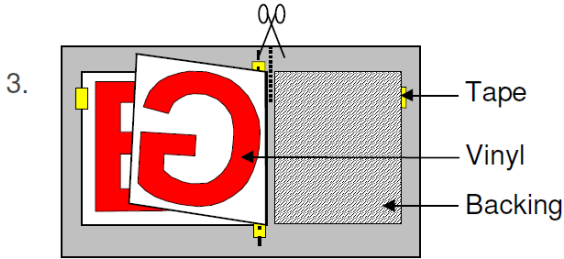

Cut the positioning tape. Fold one half on top of the other. Remove and cut the backing as far as the hinge.

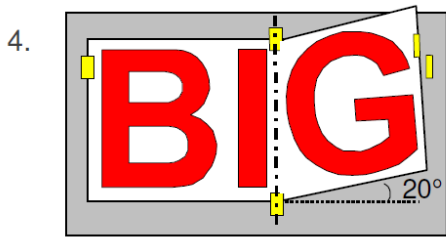

Fold the hinge back making sure that you leave a space between the vinyl and the substrate surface (angle of  $\pm 20^\circ$ ) in order to avoid pre-adhesion.

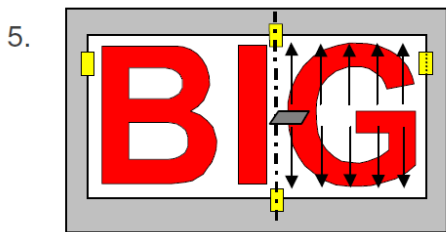

Squeegee firmly from the centre outwards in overlapping movements. Repeat the same set of actions for the other section of the lettering or logo.

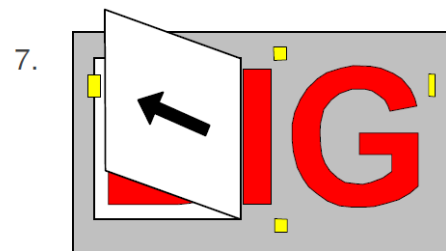

Remove the AT at a steady speed, at a cleaving angle of between 0 and 30°. Prick any air bubbles trapped between the vinyl and the substrate and squeegee once more.



7.2.c 2D areas (vinyl can be applied following these surfaces)

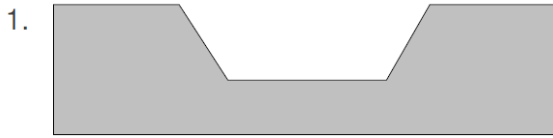

The ambient temperature and the angled surface of the object have to be ideally between 18 and 25°C.  
Clean the substrate surface and remove any grease using isopropyl alcohol.

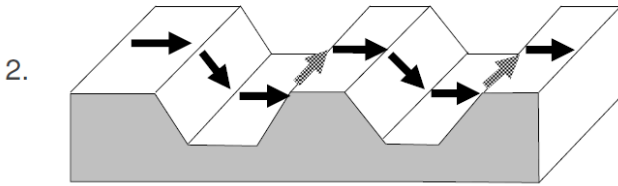

Apply the vinyl covered with MACtransfer step by step, following surfaces irregularities.  
Remove MACtransfer once finished.

7.2.d Complex curves – 3D areas (vinyl can't follow surfaces irregularities)



In some case, we need to apply some graphics on complex curves.  
On these difficult surfaces, we can't apply the vinyl following all these complex curves.  
We have therefore 2 options :

1. Apply the vinyl on the flat area, than stretching it inside the corrugated area.  
These method is very risky, and the graphic could lift this corrugated area within a few weeks/months.
2. Cutting the vinyl as described here-afterer :

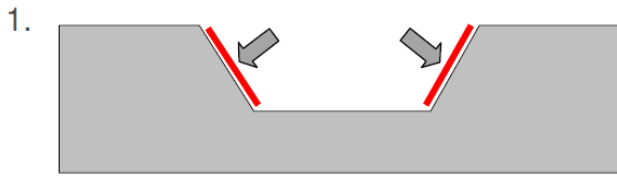

Before applying the graphic, cut a stripe of vinyl (same colour as the one used in the decoration) and apply it without tension inside the corrugation.

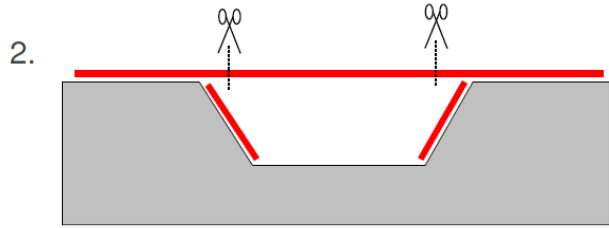

Apply the decoration on the vehicle. Cut the film.

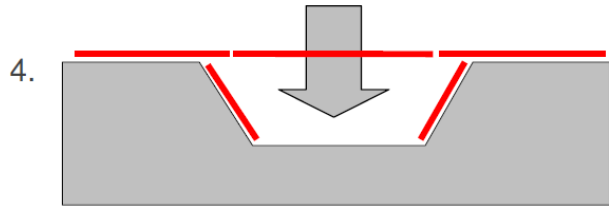

Apply the cut vinyl without tension in the corrugation.

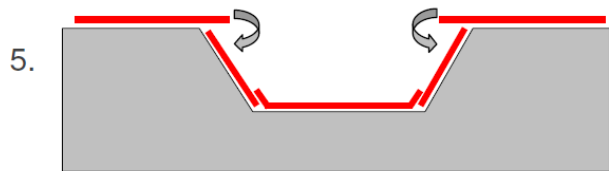

Apply the cut edges.

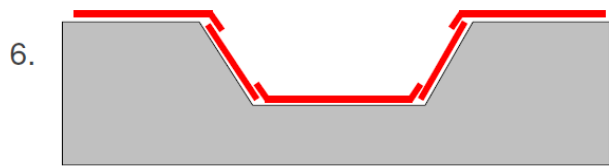

Proceeding in that way assure to the final customer a safe application. The small cuts are almost invisible.

### 7.2.e. Rivets

If decorating a vehicle with rivets, only MACal 9800 Pro or Cast can be used.

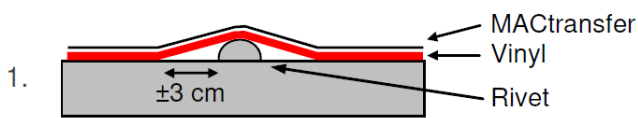

Apply the MACal 9800 Pro using the dry method described earlier, to the whole area of the surface of application, leaving a  $\pm 3$  cm gap between the vinyl and the substrate, around rivets.

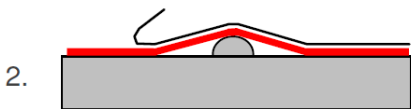

Remove the application tape at a steady speed and a cleaving angle of 0 to 30°.

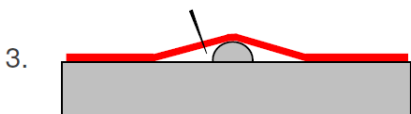

Collect the bubble around the rivet without putting the vinyl out of shape. Prick several holes in the vinyl around the rivet.

4.

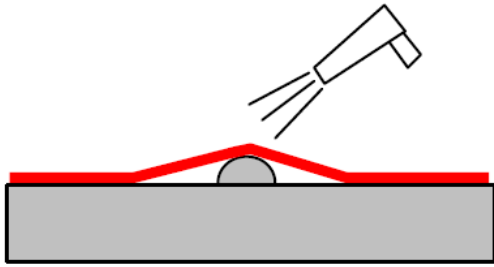

Heat MACal 9800 Pro with a heat gun (at  $\pm 250^{\circ}\text{C}$ ).  
Squeeze out any air trapped between the vinyl and the rivet using your finger.

5.

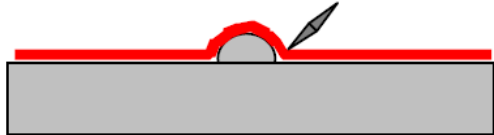

Press the film firmly around the rivet with your finger or a plastic squeegee.

6.

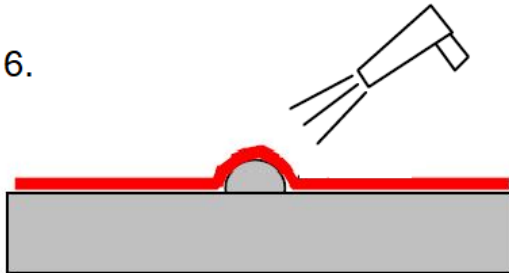

Finish off by stabilising the vinyl with a heat gun (air temperature at  $\pm 650^{\circ}\text{C}$ ).

### 7.3 Transparent, translucent or etched films

For transparent, translucent or etched film like MACcrystal 8400, MACal 9700 & Glass Decor range, the film should always be applied in the same direction, never at  $90^{\circ}$  angle as this could lead to a change in colour (arrows below indicate machine direction in the PSA roll)

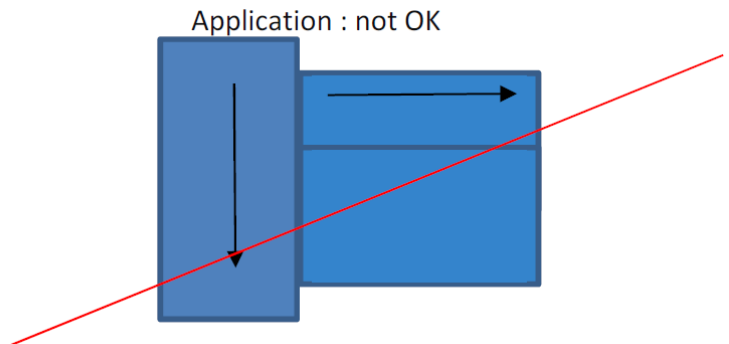
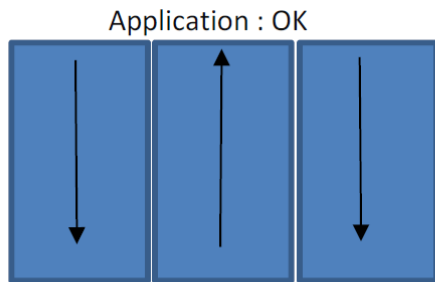

In the following picture, one piece of coloured vinyl was applied in the opposite direction leading to a change in colour.





MACtac Sealer is required wherever your graphic is going to be repeatedly exposed to liquids that will attach the adhesive, such as fuel, solvents, milk, etc. Apply two strips of paper tape: one on the substrate away from the edge of the graphic and one on the top of the graphic. Using a ¼" brush and an edge sealing varnish, brush along the edge in smooth, continuous motion. Make sure the entire edge is sealed. Remove the paper tape 15 minutes after the application.

Note: overlay a part or the entire surface of window with a graphic can entail heating of the substrate. That can cause thermal shock or stress resulting in glass breakage or cracking. MACtac will not assume any responsibility in case of window breakage.

## 8. Vinyl Removal

In the case of short-term advertising campaigns, removable self-adhesive films such as MACal 8900 Pro can be used. These films can be removed without any difficulty at ambient temperature (from 15 to 40°C), without leaving adhesive residue on most common surfaces.

In the case of markings with permanent self-adhesive vinyls, we recommend to remove them with heat :

- Heat the vinyl to a temperature of 70-80°C using a heat gun (air temperature of ±300°C).
- Peel off the permanent marking film - small pieces at a time. Keep the angle between removed film and substrate between 45° and 80°: Angles over 90° may increase the risk of adhesive transfer on the surface.
- Chemical products for easier vinyl removal are also available in shops. Follow the manufacturer's instructions carefully.
- Eventual adhesive residue can be removed with a towel soaked in isopropyl alcohol, denatured petrol or MACtac Remover.

*Important notice Information on physical and chemical characteristics and values in this document are based upon tests we believe to be reliable and do not constitute a warranty. They are intended only as a source of information and are given without guarantee and do not constitute a warranty. Purchasers should independently determine, prior to use, the suitability of this material to their specific use.*

*All technical data are subject to change. In case of any ambiguities or differences between the English and foreign versions of this document, the English version shall be prevailing and leading.*

*Disclaimer and warranty Avery Dennison warrants that its Products meet its specifications. Avery Dennison gives no other express or implied guarantees or warranties with respect to the Products, including, but not limited to, any implied warranties of merchantability, fitness for any particular use and/or non infringement. All Avery Dennison products are sold with the understanding that the purchaser has independently determined the suitability of such products for its purposes. The period of warranty is one (1) year from the date of shipment unless expressly provided otherwise in the product data sheet. All Avery Dennison's products are sold subject to Avery Dennison's general terms and conditions of sale, see <http://terms.europe.averydennison.com>. Avery Dennison's aggregate liability to Purchaser, whether for negligence, breach of contract, misrepresentation or otherwise, shall in no circumstances exceed the price of the defective, non-conforming, damaged or undelivered Products which give rise to such liability as determined by net price invoices to Purchaser in respect of any occurrence or series of occurrences. In no circumstances shall Avery Dennison be liable to Purchaser for any indirect, incidental or consequential loss, damage or injury, including without limitation, loss of anticipated profits, goodwill, reputation, or losses or expenses resulting from third party claims.*